







Screens in plexiglass / Plexiglass screens

<p>W 31 1/2" D 11 1/16" x H 31 1/2" [P]</p>  <p>300.FP.67.08 Plexiglass</p>	<p>W 39 3/8" D 11 1/16" x H 31 1/2" [P]</p>  <p>300.FP.67.10 Plexiglass</p>	<p>W 39 3/8" D 9 1/2" x H 26" [P]</p>  <p>300.FR.22.10 Plexiglass</p>
---	--	--

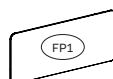
Frontal panels Sp. 0,8 - 1
/ Frontal panels D. 5/16" - 3/8"

<p>D 3/8" x H 15 3/8" [V]</p>  <p>300.FP.06.06 W 25 3/61" 300.FP.06.07 W 31 1/8" 300.FP.06.09 W 39" 300.FP.06.11 W 46 7/8" 300.FP.06.13 W 54 3/4" 300.FP.06.15 W 62 5/8" 300.FP.06.17 W 70 1/2" 300.FP.06.19 W 78 3/8" Melaminico/Melamine</p>	<p>D 5/16" x H 15 3/8" [V]</p>  <p>300.FP.V1.06 W 25 3/61" 300.FP.V1.07 W 31 1/8" 300.FP.V1.09 W 39" 300.FP.V1.11 W 46 7/8" 300.FP.V1.13 W 54 3/4" 300.FP.V1.15 W 62 5/8" 300.FP.V1.17 W 70 1/2" 300.FP.V1.19 W 78 3/8" Vetro/Glass</p>
---	--

Frontal panels H 65
/ Frontal panels H 25 5/8"

<p>D 3/8" x H 25 5/8" [P]</p>  <p>300.FP.09.06 W 25 3/61" 300.FP.09.07 W 31 1/8" 300.FP.09.09 W 39" 300.FP.09.11 W 46 7/8" 300.FP.09.13 W 54 3/4" [★] 300.FP.09.15 W 62 5/8" [★] 300.FP.09.17 W 70 1/2" [★] 300.FP.09.19 W 78 3/8" [★] Melaminico/Melamine</p>	<p>D 3/16" x H 25 5/8" [P]</p>  <p>300.FP.69.06 W 25 3/16" 300.FP.69.11 W 46 7/8" 300.FP.69.13 W 54 3/4" [★] 300.FP.69.15 W 62 5/8" [★] Plexiglass</p>
---	---

[★] N.B.: Per i frontal con lunghezza maggiore o uguale ai 139 cm, ordinare 2 kit di supporti per frontal panel / Note: For frontal panels with a length greater than or equal to 54 3/4", order 2 kits of clamps-supports for frontal panels

Frontal panel fonoassorbenti Sp. 3
/ Acoustic frontals panels T. 1 3/16"

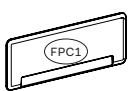
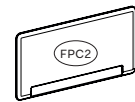
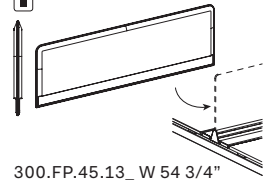
<p>D 1 3/16" x H 15 3/8" [P]</p>  <p>300.FP.40.06 W 25 3/61" 300.FP.40.07 W 31 1/8" 300.FP.40.09 W 39" 300.FP.40.11 W 46 7/8" 300.FP.40.13 W 54 3/4" 300.FP.40.15 W 62 5/8" 300.FP.40.17 W 70 1/2" Tessuto/Fabric</p>	<p>D 1 3/16" x H 23 1/4" [P]</p>  <p>300.FP.50.13 W 54 3/4" 300.FP.50.15 W 62 5/8" Tessuto/Fabric</p>	<p>D 1 3/16" x H 15 3/8" [P]</p>  <p>300.FP.45.13 W 54 3/4" 300.FP.45.15 W 62 5/8" Frontal panel per profilo attrezzabile DV801 / Frontal panel for accessories profile DV801</p>
---	--	--

Accessori per frontal panels in melaminico / Accessories for melamine frontal panels

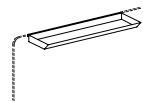
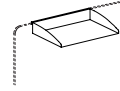
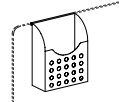
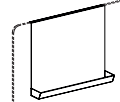
<p>W 2 9/16" D 2 9/16" x H 3 3/8" [P]</p>  <p>300.FA.01.01</p>	<p>W 19 3/4" D 6 11/16" x H 1 3/16" [P]</p>  <p>300.FA.02.05</p>	<p>W 12 3/16" D 8 11/16" x H 2" [P]</p>  <p>300.FA.04.03</p>	<p>W 9 1/16" D 3 15/16" x H 11 7/16" [P]</p>  <p>300.FA.06.02</p>	<p>W 13 6/8" D 2 9/16" x H 11 7/8" [P]</p>  <p>300.FA.08.03</p>
--	---	---	--	--

[Note:] Non utilizzabile su frontal panels in plexiglass e frontal panels in tessuto fonoassorbente / Not usable for plexiglass frontal panels and acoustic frontal panels

Morsetti e supporti in nylon per frontal panels Sp. 0,5 - 0,8 - 1 - 3 / Nylon clamps for frontal panels T. 3/16" - 5/16" - 3/8" - 1 3/16" [N]

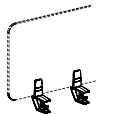
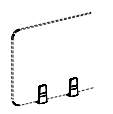
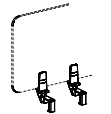
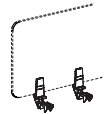
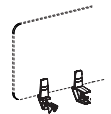
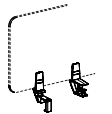
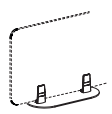
 <p>300.FP.27.00 Per piani / For worktops</p>	 <p>300.FP.28.00 Per piani-binari / For worktops-track</p>	 <p>300.FP.29.00 Per gamba (serie DV801 e DV802) / For leg (series DV801 and DV802)</p>	 <p>300.FP.30.00 Per gamba (serie DV805) / For leg (serie DV805)</p>	 <p>300.FP.31.00 Per piano-gamba (serie DV805) / For worktop-leg (serie DV805)</p>	 <p>300.FP.32.00 Per piano-gamba (serie DV801 e DV802) / For worktop-leg (series DV801 and DV802)</p>	 <p>300.FP.34.04 Free standing per piani / Free standing for worktops</p>
---	---	--	---	---	---	--

Per frontal panels / For frontal panels [FP1] [FP65] [FPP] [FP08] [FPC1] [FPC2]

Morsetti e supporti in ZAMA per frontal panels Sp. 0,5 - 0,8 - 1 - 3 / Zamak clamps for frontal panels T. 3/16" - 5/16" - 3/8" - 1 3/16" [Z]

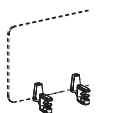
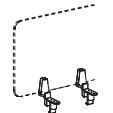
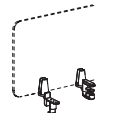
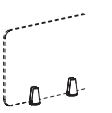
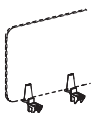
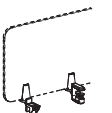
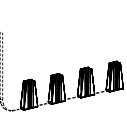
 <p>300.FP.10.00 Per piani / For worktops</p>	 <p>300.FP.20.00 Per gamba (serie DV801 e DV802) / For leg (series DV801 and DV802)</p>	 <p>300.FP.21.00 Per piano-gamba (serie DV801 e DV802) / For worktop-leg (series DV801 and DV802)</p>	 <p>300.FP.22.00 Per piani-binari / For worktops-track</p>	 <p>300.FP.23.00 Per gamba (serie DV805) / For leg (serie DV805)</p>	 <p>300.FP.24.00 Per piano-gamba (serie DV805) / For worktop-leg (serie DV805)</p>	 <p>300.FP.26.00 Per FP 1; Per profilo attrezzabile (serie DV801) / For FP 1; For accessory profile (serie DV801)</p>
---	--	--	---	---	--	--

Per frontal panels / For frontal panels [FP1] [FP65] [FPP] [FP08] [FPC1] [FPC2]

Note:

[1] Le dimensioni sono espresse in pollici - consultare il listino prezzi per le caratteristiche tecniche, i codici degli articoli e delle finiture / Dimensions are stated in inch - for technical characteristics, article code numbers and finishing see price list;

[P] Prodotti non in pronta consegna. Per la disponibilità contattare l'ufficio commerciale / Items not in prompt delivery. Please contact the commercial department to check availability;

[N.B.] : Articoli completamente smontati / N.B.: Completely knocked-down

[N] Morsetti o supporti in nylon / Nylon clamps

[Z] Morsetti o supporti in ZAMA / Zamak clamps

[P] Plexiglass

[V] Vetro/Glass.

Frontal panels H 65 con supporto freestanding integrato
/ Frontal panels H 25 5/8" with freestanding bracket integrated

W 30 5/16" D 7 1/8"
x H 25 5/8"
■ (N)

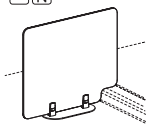

300.FR.24.13_
Melaminico / Melamine

W 30 5/16" D 7 1/8"
x H 25 5/8"
■ (N) (P)

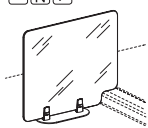

300.FR.24.07_
Plexiglass

Frontal panels con supporti integrati
/ Frontal panels with clamps

W 30 5/16" D 3/8" x H 15 3/8"
(N)

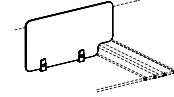

300.FR.26.07_
Per piani melaminico
/ For worktops melamine

Partitions

W 35 7/16" D 11 7/8"
x H 70 7/8"
■ (F) (G)



300.EM.07.00_
Melaminico o laminato bianco lucido
/ Melamine or polished white

W 35 7/16" D 13 6/8"
x H 70 7/8"
■ (F) (G)

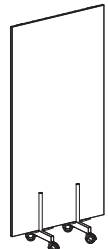

300.EM.08.00_
Melaminico o laminato bianco lucido
/ Melamine or polished white
Su ruote / On wheels

Accessori per partizioni
/ Accessories for partitions

W 2 3/4" D 2 3/4"
x H 3 9/16"



300.FA.09.01
Portapenne / Pen holder

Frontal panels a pavimento / Floor frontal panels

W 51 3/16" D 7 1/8"
x H 55 1/8"
■ (N)

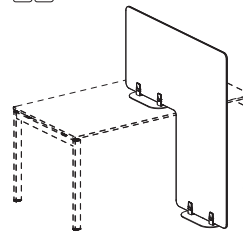

300.FR.25.07_
Melaminico / Melamine

Frontal panel fonoassorbenti sp. 3 cm
/ Acoustic frontals panels 1 3/16" thick

D 1 3/16" x H 15 3/8"

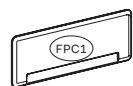

300.FP.40.06 W 25 3/16"
300.FP.40.07 W 31 1/8"
300.FP.40.09 W 39"
300.FP.40.11 W 46 7/8"
300.FP.40.13 W 54 3/4"
300.FP.40.15 W 62 5/8"
300.FP.40.17 W 70 1/2"
Tessuto / Fabric

D 1 3/16" x H 23 1/4"

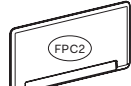

300.FP.50.13 W 54 3/4"
300.FP.50.15 W 62 5/8"
Tessuto / Fabric

Frontal panel per profilo attrezzabile DV801
/ Frontal panel for accessories profile DV801

D 1 3/16" x H 15 3/8"
■

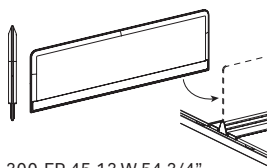

300.FP.45.13 W 54 3/4"
300.FP.45.15 W 62 5/8"
Frontal panel per profilo attrezzabile DV801
/ Frontal panel for accessories profile DV801

Morsetti e supporti in nylon per frontal panels Sp. 3 / Nylon clamps for frontal panels 3/16" thick (N)

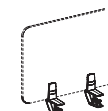

300.FP.27.00
Per piani / For worktops

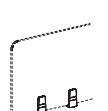

300.FP.28.00
Per piani-binari
/ For worktops-track

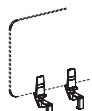

300.FP.29.00
Per gamba (serie DV801 e DV802)
/ For leg (series DV801 and DV802)

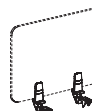

300.FP.30.00
Per gamba (serie DV805)
/ For leg (serie DV805)

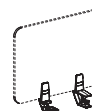

300.FP.31.00
Per piano-gamba (serie DV805)
/ For worktop-leg (serie DV805)

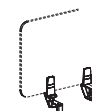

300.FP.32.00
Per piano-gamba (serie DV801 e DV802) / For worktop-leg (series DV801 and DV802)

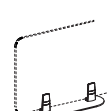

300.FP.34.04
Free standing per piani
/ Free standing for worktops

Per frontal panels / For frontal panels (FPC1) (FPC2)

Morsetti e supporti in ZAMA per frontal panels Sp. 3 cm / Zamak clamps for frontal panels 1 3/16" thick (Z)

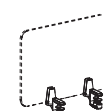

300.FP.10.00
Per piani / For worktops

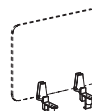

300.FP.20.00
Per gamba (serie DV801 e DV802)
/ For leg (series DV801 and DV802)



300.FP.21.00
Per piano-gamba (serie DV801 e DV802) / For worktop-leg (series DV801 and DV802)



300.FP.22.00
Per piani-binari
/ For worktops-track

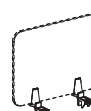

300.FP.23.00
Per gamba (serie DV805)
/ For leg (serie DV805)

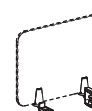

300.FP.24.00
Per piano-gamba (serie DV805)
/ For worktop-leg (serie DV805)

Per frontal panels / For frontal panels (FPC1) (FPC2)

Note:

1 Le dimensioni sono espresse in pollici - consultare il listino prezzi per le caratteristiche tecniche, i codici degli articoli e delle finiture / Dimensions are stated in inch - for technical characteristics, article code numbers and finishing see price list;

■ Prodotti non in pronta consegna. Per la disponibilità contattare l'ufficio commerciale / Items not in prompt delivery. Please contact the commercial department to check availability;

■ Le partizioni in laminato lucido (WL) possono essere utilizzate come lavagne con gli appositi pennarelli / Polished white laminate (WL) partitions can be used as blackboards with the appropriate markers

(P) Plexiglass

(N) Morsetti o supporti in nylon / Nylon clamps

(Z) Morsetti o supporti in ZAMA / Zamak clamps

(G) Piani in Gres porcellanato / Worktops in Porcelain neware;

(V) Vetro / Glass.

Pannello ceiling sospeso
/Suspended ceiling panel

W 23 5/8" x H 23 5/8"

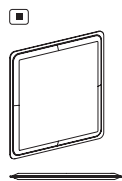

300.PC.05.01

D 1 3/16" H 9 1/16"
x W 27 9/16"

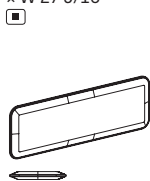

300.PC.07.01

Kit per ceiling sospeso
/Kit for suspended ceiling

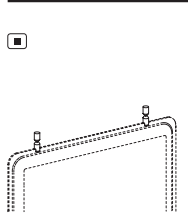

300.KT.05.00
Variante per fissaggio a soffitto
/Ceiling fixing variant

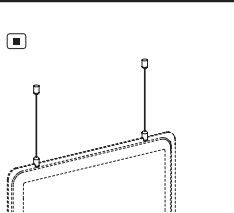

300.KT.05.00
Variante per fissaggio a soffitto con cavi
/Ceiling fixing variant with cables

Pannello ceiling per controsoffitto
/Ceiling panel for suspended ceiling

W 23 5/8" x H 23 5/8"

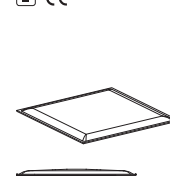

300.PC.06.01

Pannelli wall/Wall panels

W 27 9/16"
x H 22 1/2"

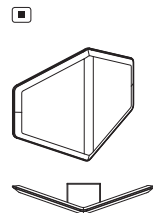

300.PC.03.01
Concavo/Concave

W 27 9/16"
x H 22 1/2"

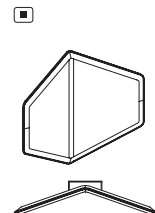

300.PC.04.01
Convesso/Convex

Tavolini caffè universali /Universal coffee tables

Ø 23 5/8" x H 17 6/8"



300.TT.04.06_
Con gambe metalliche
/With metal legs

Ø 23 5/8" x H 17 6/8"



300.TT.04.06_
Con gambe metalliche
/With metal legs

Ø 23 5/8" x H 17 6/8"



300.TT.04.06_
Con gambe coniche in legno
/With wooden conic legs

Ø 23 5/8" x H 17 6/8"



300.TT.04.06_
Con gambe coniche in legno
/With wooden conic legs

Ø 23 5/8" x H 29 1/8"



804.TR.20.06_
Con gambe freestanding DV804
/With freestanding legs DV804

Ø 23 5/8" x H 29 1/8"



804.TR.20.06_
Con gambe freestanding DV804
/With freestanding legs DV804

Ø 23 5/8" x H 29 1/8"



300.TR.20.06_
Con gambe coniche in legno
/With wooden conic legs

Ø 23 5/8" x H 29 1/8"



300.TR.20.06_
Con gambe coniche in legno
/With wooden conic legs

W 39 3/8" D 39 3/8"
x H 17 6/8"



300.TT.05.10_
Con gambe metalliche
/With metal legs

W 39 3/8" D 39 3/8"
x H 17 6/8"



300.TT.05.10_
Con gambe metalliche
/With metal legs

W 39 3/8" D 39 3/8"
x H 17 6/8"



300.TT.05.10_
Con gambe coniche in legno
/With wooden conic legs

W 39 3/8" D 39 3/8"
x H 17 6/8"



300.TT.05.10_
Con gambe coniche in legno
/With wooden conic legs

W 39 3/8" D 39 3/8"
x H 29 1/8"



804.TR.31.10_
Con gambe freestanding DV804
/With freestanding legs DV804

W 39 3/8" D 39 3/8"
x H 29 1/8"



804.TR.31.10_
Con gambe freestanding DV804
/With freestanding legs DV804

Tavolini caffè universali
/Universal coffee tables

W 39 3/8" D 39 3/8"
x H 29 1/8"



300.TR.31.10_
Con gambe coniche in legno
/With wooden conic legs

W 39 3/8" D 39 3/8"
x H 29 1/8"



300.TR.31.10_
Con gambe coniche in legno
/With wooden conic legs

Tavolini caffè/Coffee tables

D 23 5/8" x H 16 6/8"



300.TT.02.06_ W 23 5/8"
300.TT.02.12_ W 47 1/4"

D 23 5/8" x H 16 6/8"



300.TT.03.06_ W 23 5/8"
300.TT.03.12_ W 47 1/4"

D 23 5/8" x H 17 6/8"

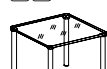

300.TV.25.06 W 23 5/8"
300.TV.25.12 W 47 1/4"

D 23 5/8" x H 17 6/8"



910.TT.03.06_ W 23 5/8"
910.TT.03.12_ W 47 1/4"



Gamba a "X"
/"X" shaped leg
Gamba a "L"
/"L" shaped leg

H 17 6/8" Ø 31 1/2"



817.TT.04.08_

Note:

1 Le dimensioni sono espresse in pollici - consultare il listino prezzi per le caratteristiche tecniche, i codici degli articoli e delle finiture/Dimensions are stated in inch - for technical characteristics, article code numbers and finishing see price list;

■ Prodotti non in pronta consegna. Per la disponibilità contattare l'ufficio commerciale/Items not in prompt delivery. Please contact the commercial department to check availability;

N Morsetti o supporti in nylon /Nylon clamps

Z Morsetti o supporti in ZAMA / Zamak clamps

Canalizzazione – Elettrificazione – Accessori/Wire management – Electrification – Accessories

300.AP.25.04 W 15 3/4" 300.AP.25.06 W 23 5/8" 300.AP.25.08 W 31 1/2" 300.AP.25.10 W 39 3/8" 300.AP.25.12 W 47 1/4" 300.AP.25.14 W 55 1/8" 300.AP.25.16 W 63" 300.AP.25.18 W 70 7/8"	300.AP.26.06 W 23 5/8" 300.AP.26.08 W 31 1/2" 300.AP.26.10 W 39 3/8" 300.AP.26.12 W 47 1/4" 300.AP.26.14 W 55 1/8" 300.AP.26.16 W 63" 300.AP.26.18 W 70 7/8"	300.AP.03.01	300.AP.11.01	300.AP.30.02 W 9 1/2" 300.AP.30.06 W 23 5/8" 300.AP.30.09 W 35 7/16" 300.AP.30.11 W 43 3/8" 300.AP.30.14 W 55 1/8" 300.AP.30.16 W 63"	300.CL.01.40 W 45 1/4"
		300.AP.04.01			300.AP.20.00 W 22 1/2"

300.AP.31.06	300.APV1.00	300.APV2.15	300.AP.U1.01 Ø 2 3/8" 300.AP.U2.02 Ø 3 1/8" 300.AP.U3.03 Ø 4"	300.AP.T7.01 Ø 2 3/8" 300.AP.T8.01 Ø 3 1/8"	300.FA.09.01 Portapenne / Pen holder
					W 2 3/4" D 2 3/4" × H 3 9/16"

300.AC.38.02 H 1" 300.AC.38.03 H 1 3/16"	300.AC.67.03 Marsupio per top access 300.AC.38.__ / Basket for top access 300.AC.38.__	300.AC.26.02_ W 9 5/8" 300.AC.26.03_ W 13 5/8" 300.AC.26.04_ W 17 1/2"	300.AC.20.02_ W 9 5/8" 300.AC.20.03_ W 13 5/8" 300.AC.20.04_ W 17 1/2"	300.AC.25.02 W 9 1/4" 300.AC.25.03 W 13 3/16" 300.AC.25.04 W 17 1/8" Marsupio/Basket	300.AC.33.02
W 12 5/8" × D 4 7/8"		D 6 7/8"			W 9 1/2" D 3 15/16" × H 10/16"

300.AP.S1.02 300.AP.S2.02 UK 300.AP.S3.02 US Per top access 300.AC.26.02 /For top access 300.AC.26.02	300.AP.S1.03 300.AP.S2.03 UK 300.AP.S3.03 US Per top access 300.AC.26.03 /For top access 300.AC.26.03	300.AP.S1.04 300.AP.S2.04 UK 300.AP.S3.04 US Per top access 300.AC.26.04 /For top access 300.AC.26.04	300.AP.T8.11 Tappo con 1 presa elettrica + USB (solo ricarica) + passacavo / Plug with 1 electrical socket + USB (only charge) + outlet lid	300.AP.T8.14 Tappo con 1 presa elettrica + USB (solo ricarica) + HDMI / Plug with 1 electrical socket + USB (only charge) + HDMI	300.AP.T8.17 Tappo con 1 presa elettrica + USB (solo ricarica) + RJ45 / Plug with 1 electrical socket + USB (only charge) + RJ45
W 8 1/8"	W 11 7/8"	W 16 4/8"	Ø 3 1/8"		

300.AT.A6.02 300.AT.A7.02 UK 300.AT.A8.02 US	300.AT.A6.03 300.AT.A7.03 UK 300.AT.A8.03 US	300.AT.A6.04 300.AT.A7.04 UK 300.AT.A8.04 US	812.AC.08.01 812.AC.08.01 – UK 812.AC.08.01 – US Presa USB (solo ricarica) / USB Socket (only charge)	300.AP.T4.01 300.AP.T5.01 UK 300.AP.T6.01 US	300.AC.16.02_	300.AC.06.05_
W 8 1/4"	W 10"	W 15 3/8"	L 5 P 3 × H 5			

Bracci porta video/Arms for video support

300.AC.02.01 Braccio porta video mobile su piano /Dynamic arm for video support on deskbase	300.AC.02.02 Doppio braccio porta video mobile su piano/2 dynamic arms for video support on deskbase	300.AC.01.01 Braccio porta video statico su palo/Static arm for video support on pole	300.AC.01.02 Doppio braccio porta video statico su palo/2 static arms for video support on pole

Note:

- ① Le dimensioni sono espresse in pollici – consultare il listino prezzi per le caratteristiche tecniche, i codici degli articoli e delle finiture/Dimensions are stated in inch – for technical characteristics, article code numbers and finishing see price list;
- Prodotti non in pronta consegna. Per la disponibilità contattare l'ufficio commerciale / Items not in prompt delivery. Please contact the commercial department to check availability;
- Ⓜ Articoli prodotti solo su richiesta/Items produced only on demand;
- Ⓜ Fino ad esaurimento/Until exhaustion.

Pensile / Overhead unit

W 30 3/4" D 13 6/8"
× H 16 4/8"

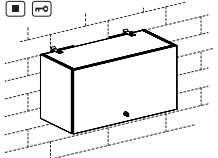

300.AC.75.07_

Mensola con supporti/Wall-shelf with supports

D 11 7/8" × H 1"

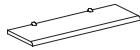

300.AC.M1.09_ W 35 7/16"
300.AC.M1.13_ W 51 3/16"
300.AC.M1.18_ W 70 7/8"

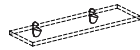

300.AC.M2.00
Coppia ovetto reggi-mensola
/ Pair of egg-shaped wall-shelf support

Contenitori multiuso/Multipurpose units

W 13 6/8" D 9 1/2"
× H 13 6/8"



300.AC.14.03_
Box multiuso
/Storage box

Tavoli su ruote con piano ribaltabile/Tables on castors with flip worktop

D 27 9/16" - H 29 1/8"

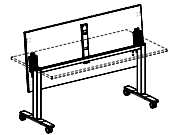

300.TF.01.08_ W 31 1/2"
300.TF.01.10_ W 39 3/8"
300.TF.01.12_ W 47 1/4"
300.TF.01.14_ W 55 1/8"
300.TF.01.16_ W 63"
300.TF.01.18_ W 70 7/8"

D 31 1/2" - H 29 1/8"

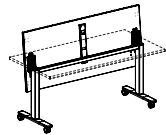

300.TF.02.08_ W 31 1/2"
300.TF.02.10_ W 39 3/8"
300.TF.02.12_ W 47 1/4"
300.TF.02.14_ W 55 1/8"
300.TF.02.16_ W 63"
300.TF.02.18_ W 70 7/8"

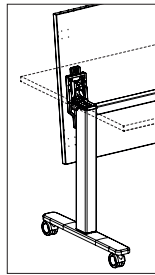

D 3/8" - H 12 3/16"



300.MP.10.08_ W 18 5/16"
300.MP.10.10_ W 26 3/16"
300.MP.10.12_ W 34 1/8"
300.MP.10.14_ W 41 15/16"
300.MP.10.16_ W 49 13/16"
300.MP.10.18_ W 57 5/16"
Modesty panel per tavolo con piano ribaltabile
/Modesty panel for table with flip worktop

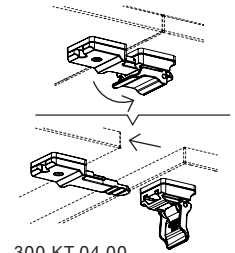

300.KT.04.00
Ganci per collegare in linea tavoli folding
/Hooks to connect folding desks in line

Tavoli su gamboni regolabili/Tables on adjustable metal column

H 27 3/8" - 44 11/16"

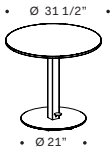

300.TR.60.08_

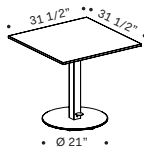

300.TR.61.08_

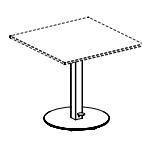

300.TR.62.00_

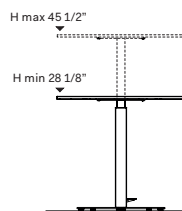

H 23/32"

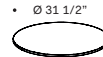

801.PR.01.08_ Ø 31 1/2"

H 23/32" P 31 1/2"

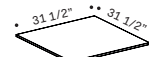

801.PR.02.08_ W 31 1/2"

[Note:] Regolazione con sistema pneumatico a pedale. Piano in melaminico sp. 18 mm con bordi perimetrali in ABS/Adjustment with pneumatic pedestalsystem. Worktops in melamine 23/32" thick with ABS perimetrical edges

Colonne e gamboni/Metal colums

H 28 1/8"

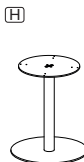

300.AC.17.06 Ø 23 5/8"

W 21 5/8" D 21 5/8"
× H 2/1/8"

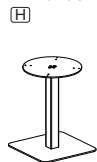

300.AC.51.08_

W 2" × D 2"



703.GM.01.01_ H 28 1/8"
802.GF.05.01_ H 28 7/16"

Note:

[1] Le dimensioni sono espresse in pollici - consultare il listino prezzi per le caratteristiche tecniche, i codici degli articoli e delle finiture/Dimensions are stated in inch - for technical characteristics, article code numbers and finishing see price list;

[] Prodotti non in pronta consegna. Per la disponibilità contattare l'ufficio commerciale / Items not in prompt delivery. Please contact the commercial department to check availability;

[] Con serratura/With lock.

[H] Gambone verniciato a polveri in bianco, alluminio o antracite / Metal column electrostatic painted in white, aluminum or anthracite;